

Switch Mode Power Supplies: SPICE Simulations and Practical Designs

Christophe Basso – August 2014

Compilation of on-line reviewers comments, readers comments, typos, mistakes and errors found by readers (or by the author himself)

Second Edition, 1st print

Chapter 1

Page 7: Figure 1.5

The resistance in Figure 1.5 is incorrectly labelled $R_{s,CL}$ whereas it should be $R_{s,OL}$. Contributed by Dmitry Kurzni, March 2015.

Page 17: Converting Power with Switches

One anonymous Amazon.com reviewer in the name of *K Rinne* or *Rimme K* (Fremont) left a detailed comment where he intends to demonstrate that my calculations are wrong. The adopted chatty style obviously identifies (t)his author. The incriminated circuit is that of Figure 1.19 in which I show a switch driving a 5- Ω resistance. In this introductory chapter, my goal is to introduce the concept of a switching converter rather than immediately going into complex analysis. I first say that using a needle volt-meter, you measure 6 V dc across the load if the 10-m Ω switch is activated during 5 μ s and released during the other 5 μ s (frequency is 100 kHz). The duty ratio is thus 50%. Because of the switch series resistance, the peak voltage across the load during the on-time is $12 \times \frac{5}{10m+5} = 11.976$ V. Which averaged by a 50% duty ratio is $11.976/2 = 5.988$ V. Now, I defy anyone to extract this exact value using a needle voltmeter. Perhaps I should have said in the text "...would measure approximately 6 V". The point is granted, merci Buddy.

Regarding the efficiency figure, I could have calculated the rms voltage across the load including the loss but I decided not to do so in equation (1.24), purposely keeping V_{in} to obtain, at the end, the classical formula for a buck converter neglecting losses, $V_{out} = DV_{in}$. All the numbers provided in the page are from simulation. That is why some discrepancies can occur between simulation and calculation since you need to call cursors and place them precisely so that a period is encompassed to run the measurement. A slight deviation or a discrete simulation point jump brings an error. In this case, the measurement returned a value of 8.475 V rms. The exact theoretical value (considering 0-s switching times, this is important) is $V_{load,peak} \sqrt{D} = 11.976 \times \sqrt{0.5} = 8.468$ V rms. Once squared and divided by the 5- Ω load, we have 14.34 W. The 14.37 W from the book are using 8.475 V rms from simulation. Now the input current. It jumps to $12/(5+10m) = 2.395$ A during the on-time and returns to 0 for the remaining 5 μ s. Its average value is thus 1.198 A which multiplied by the 12-V source leads to an input power of 14.371 W. So, theoretical efficiency is $14.341/14.371 = 99.79\%$ which is rounded to 99.8%. The efficiency from simulation is $14.365/14.394 = 99.79\%$. In this simple example, the loss in the switch is simply the difference between P_{in} and P_{out} : 30 mW in theory. This loss encompasses conduction and switching losses.

This ohmic drop will later affect the dc voltage delivered to the load but not in a straightforward way since it is weighted by the duty ratio D and the load value (see equation 2.243). Yes, you are correct, the loop will compensate these losses with the rest of the contributors in the converter.

Following a comment from the courageous Buddy Miles, Fremont, Amazon review, August 2nd 2014. The comment has been compulsively posted a few hours after Amazon opened the page for comments.

Page 19: A Filter is Needed

Another courageous anonymous Amazon.com reviewer, Monsieur *Ray Ban*, left a comment on the second example shown in Figure 1.21. In this transition example, I show a switch driving a series inductance without any freewheel diode. I explain in the text that if no path is provided to the inductor current at the switch opening, a high-voltage oscillating will occur at the inductor left terminal, immediately destroying the switch. Then I carry on with a calculation assuming a 6-V output on the capacitor. This is where the confusion may be. I actually used a steady-state value once the diode is added as in Figure 1.22. Let's see what is actually happening if we stay with Figure 1.21. At power on, when the switch closes, the output capacitor is discharged, V_{out} is 0 V. Then the magnetizing current ramps up with a slope described by (1.32). At the end of the on-time, neglecting the on-loss, the inductor current peaks to $\frac{12-0}{100\mu} \times 5\mu = 600$ mA as correctly pointed by my friend *Ray* (can I call you

Ray?). Then, as the switch opens, the voltage at the inductor left terminals collapses to a peak value depending on the parasitic capacitance at the SW node. If we assume that parasitic capacitor C_{par} to be 100 pF, the voltage peaks to $V_{SW} = -I_{L,peak} \sqrt{L/C_{par}} = -600m \times \sqrt{100\mu/100p} = -600$ V and oscillates freely afterwards. For a 6-V buck powered from a 12-V source, you may want to use a 20-V power MOSFET. Needless to say that the switch is destroyed quickly unless it is able to absorb the peak power as its body diode avalanches. The below figure shows the waveforms corresponding to Figure 1.21.

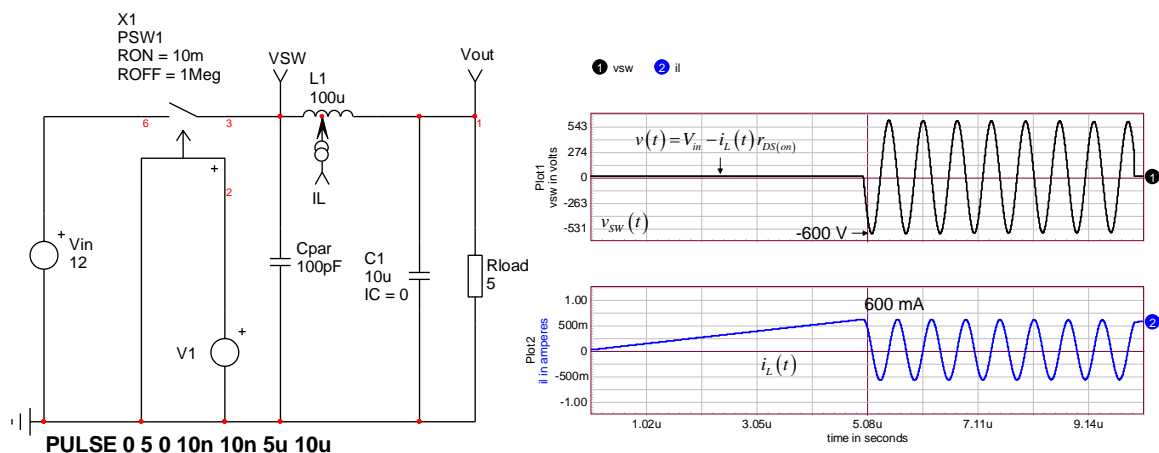

Now, if we add a freewheel diode as we have in a classical buck configuration (in Figure 1.22), what is the inductor doing at power on, when V_{out} is discharged? In other words, what start-up sequence do we have in open loop? As we previously calculated, when the switch closes, the current ramps up in the inductor and feeds the capacitor and the load. The inductor on-slope depends on the inductor instantaneous voltage and the inductor value. During the on-time, the inductor left terminal sees V_{in} minus the power switch drop (which

depends on the instantaneous inductor current) while the right terminal sees V_{out} building up as charges are poured into the capacitor. As an immediate remark, the on-slope varies as V_{out} rises cycle after cycle. During the off-time, the slope is not constant either during the start-up sequence. The inductor left terminal sees the diode $-V_f$ while the right terminal sees V_{out} building up. Accurate definitions for the on and off-slopes in a buck converter during start-up are thus:

$$s_{L,on}(t) = \frac{(V_{in} - i_L(t)r_{DS(on)}) - v_{out}(t)}{L} \approx \frac{V_{in} - v_{out}(t)}{L}$$

$$s_{L,off}(t) = -\frac{v_f(t) + v_{out}(t)}{L}$$

At steady-state, these definitions greatly simplify to:

$$S_{L,on} \approx \frac{V_{in} - V_{out}}{L} \text{ and } S_{L,off} = -\frac{V_f + V_{out}}{L} \approx -\frac{V_{out}}{L} \text{ for } V_f \ll V_{out}$$

The current in the capacitor at the end of the on-time is the peak inductor current $I_{L,peak}$ minus the current already absorbed by the load, $V_{out,on}/R$. If we calculate the amount of charge Q brought to the capacitor at the end of the on-time then we have an equation to get the first V_{out} step. The capacitor current at the end of the on time is $I_{C,peak-on} = I_{L,peak-on} - \frac{V_{out,on}}{R}$. This

$$\text{translates into the simple equation } Q = VC: \frac{\left(I_{L,peak} - \frac{V_{out,on}}{R}\right)}{2} t_{on} = V_{out,on} C$$

Factoring and rearranging gives V_{out} at the end of the first on-time:

$$V_{out,on} = \frac{I_{L,peak-on} t_{on}}{2C + \frac{t_{on}}{R}} = \frac{0.6 \times 5\mu}{20\mu + 1\mu} = 142.8 \text{ mV}$$

Then the switch opens and the inductor current now circulates in the freewheel diode. The inductor voltage reverses: its right terminal is at V_{out} while its left is negative, at the diode V_f . Assume it is 370 mV in the example. The inductor downslope is then $-(V_f + V_{out,on})/L$. Here, the V_f cannot be neglected as it can be significantly higher than V_{out} for the first pulses. Again the inductor current circulates in the capacitor and the load. Except that the inductive current now decreases as the inductor demagnetizes. The inductor peak at the end of the off-time is given by the downslope multiplied by t_{off} .

$$I_{L,peak-off} = I_{L,peak-on} - S_{off} t_{off} = I_{L,peak-on} - \frac{(V_f + V_{out,on})}{L} t_{off} = 0.6 - \frac{0.37 + 0.143}{100\mu} \times 5\mu \approx 574 \text{ mA}$$

The capacitor current at the end of the off-time is also the inductor current $I_{L,peak-off}$ minus the current absorbed by the load: $I_{C,peak-off} = I_{L,peak-off} - \frac{V_{out,off}}{R}$. Therefore, the updated equation to get the output voltage increment ΔV_{out} at the end of the off time is simply:

$$\frac{\left(I_{L,peak-on} - \frac{V_{out,on}}{R} + I_{L,peak-off} - \frac{V_{out,off}}{R} \right)}{2} t_{off} = \Delta V_{out} C$$

Solving for $V_{out,off}$ gives:

$$V_{out-off} = V_{out,on} + \Delta V = V_{out,on} + \frac{\left(I_{L,peak-on} - \frac{V_{out,on}}{R} + I_{L,peak-off} \right) t_{off}}{2C - \frac{t_{off}}{R}} =$$

$$= 0.136 + \frac{\left(0.6 - \frac{0.136}{5} + 0.574 \right) \times 5\mu}{2 \times 10\mu - \frac{5\mu}{5}} = 136m + 273m = 409 \text{ mV}$$

For the next switching cycle, the inductor current starts with an initial condition of 574 mA while the capacitor is already charged at 409 mV. The inductor current increases again but with a different slope as V_{out} now builds up. The next inductor peak is $0.574 + 0.58 = 1.15 \text{ A}$. The below figure describes the start-up sequence for the buck:

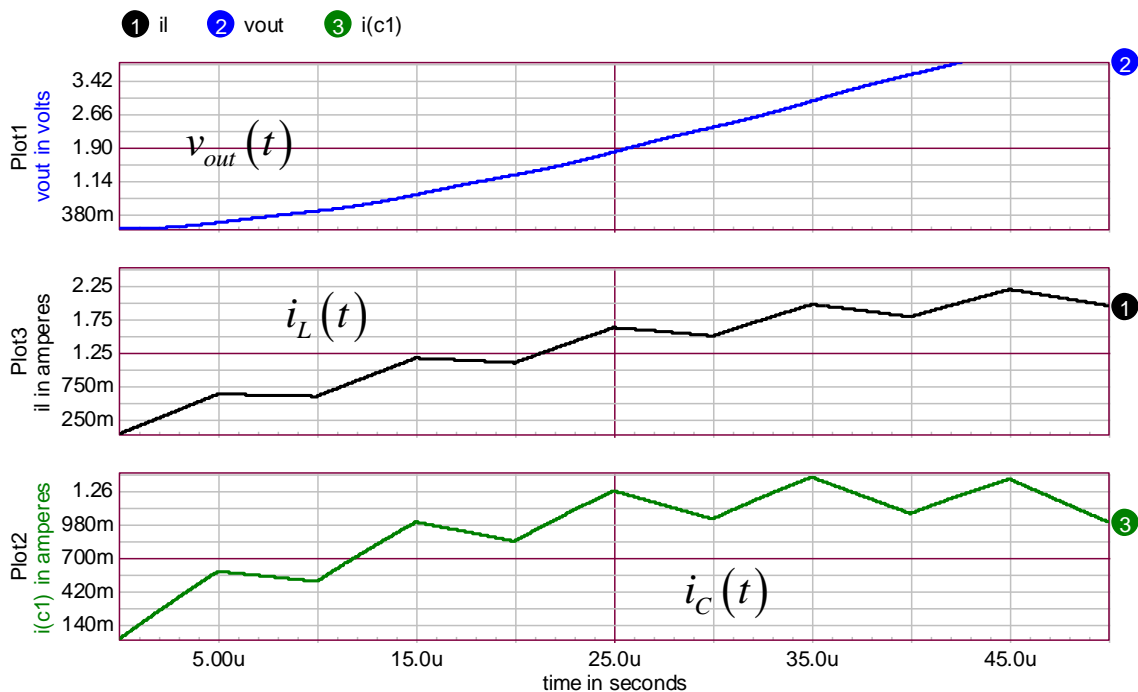

The inductor current increases and eventually overshoots, depending on the LC network quality factor. This is an open-loop simulation. In a real switching converter, there

would a cycle-by-cycle current limit and a soft-start sequence, smoothly increasing the peak setpoint for several milliseconds.

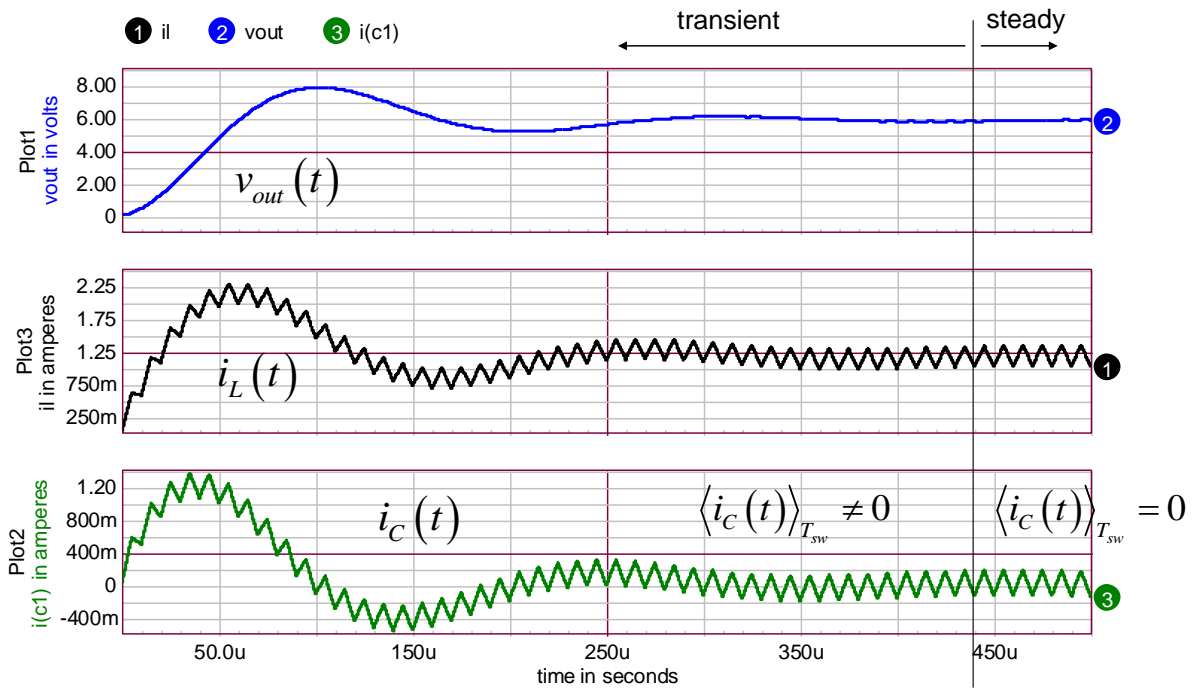

Now the remark about inductor “reset” or not “reset”. The IEEE dictionary states that the term “reset” implies a system that goes back to its original or pre-determined state. I did not find a definition for “magnetic reset”. If you consider the original inductor current state to be $i_L(0) = 0$, then a CCM-operated inductor implies that the inductor current never returns to 0 within a switching cycle. What it does in the DCM mode. Now, you can also consider the original state to be the inductor valley current at the beginning of the switching cycle. Steady-state or equilibrium implies that the inductor current at the end of the switching cycle returns to this valley current. In other words, the on-time volts-seconds equal the off-time volts-seconds as you correctly pointed out. To avoid confusion, I can also use “magnetized” or “de-magnetized” to respectively describe the inductor state in CCM and DCM.

Following a comment from Ray Ban, Amazon review, August 2nd 2014.

Page 24: the formula (1.51) is correct for the net charge change over a switching period. If we divide both sides by T_{sw} , then we have the average current definition which is 0 over the considered period of time.

$$\frac{1}{T_{sw}} \int_0^{T_{sw}} i_c(t) \cdot dt = \langle i_c(t) \rangle = 0$$

Page 72: in figure 1.78, the diode current incorrectly goes up again at the end of the D_3T_{sw} event. It should stay flat until the next D_2T_{sw} event.

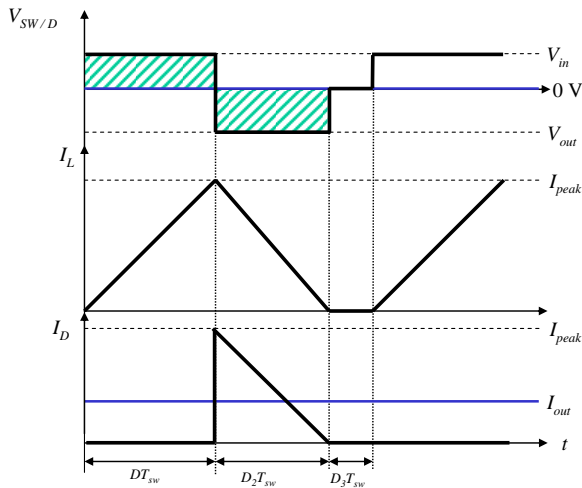

Contributed by Alexy, March 2015.

Page 85: above equation (1.286): Plugging Eq. (1.285) into (1.284)

Contributed by K. François, April 2017.

Page 87: last bullet: the damping ratio is positive: $\zeta > 0$

Contributed by K. François, April 2017.

Chapter 2

Page 130: below equation (2-100): “From Eq. (2-100)...” should be “From Eq. (2-99)...”

Contributed by Denis Zaikin, January 2017.

Page 180: the voltage source used in Figure 2.79 provides the bias point for the simulation template so that V_{out} equals 5 V for a 5-A output current. However, rather than tweaking the source to get the right dc value, a reader correctly pointed out that the dc bias value for V_c could actually be extracted from (2.172). If you extract V_c from that equation, it gives you the exact bias value to get 5 V out from the buck converter in Figure 2.79 while delivering 5 A ($I_c = 5$ A, $V_{cp} = V_{out}$):

$$V_c = R_i \left[I_c + \frac{T_{sw} V_{cp} (1 - D_0)}{2L} + \frac{D_0 S_a T_{sw}}{R_i} \right] = 1.294 \text{ V for a 2.5 kV/s external ramp.}$$

Contributed by Fred Williams, April 2016.

Page 252: the on- and off-slopes S_n and S_f must be expressed in V/s and thus be multiplied by R_i , the sense resistor. The expression then takes places in the DCM transfer function. For instance, in the expression F_m page 261 for the current-mode DCM buck-boost:

$$F_m = \frac{1}{S_n m_c T_{sw}} = \frac{1}{\frac{V_{in}}{L} R_i m_c T_{sw}}$$

Page 273: $\omega_{z_1} = \frac{R_1}{M^2 L}$ and not R_2

Page 292: an s is missing in the denominator of equation (3.27)

$$G(s) \approx -\frac{R_2}{R_1} \frac{1 + \frac{1}{sR_2C_1}}{1 + sR_2C_2} = -G_0 \frac{1 + \frac{s_z}{s}}{1 + \frac{s}{s_p}} \quad (3.27)$$

Contributed by Mahdi Fakhmanesh, December 2020.

Chapter 3

Page 295: ... placed in parallel with resistor R_2 introduced a ...

Contributed by Mahdi Fakhmanesh, December 2020.

Page 306: The caption in Figure 3.34 is wrong and should be $R_{load} = 50 \Omega$ as this is a DCM plot.

Contributed by Kubendran G., August 2021.

Page 325: The pole is contributed by C_{pole} and not C_{zero} :

$$G(s) = \frac{V_{FB}(s)}{V_{out}(s)} = -\left(\frac{1 + sR_{upper}C_{zero}}{sR_{upper}C_{zero}} \right) \left(\frac{1}{1 + sR_{pullup}C_{pole}} \right) \frac{R_{pullup}}{R_{LED}} \text{CTR} \quad (3.83)$$

$$G(s) = -\frac{1 + \frac{1}{sR_{upper}C_{zero}}}{1 + sR_{pullup}C_{pole}} \frac{R_{pullup}}{R_{LED}} \text{CTR} = -G_0 \frac{1 + \frac{s_z}{s}}{1 + \frac{s}{s_p}} \quad (3.84)$$

Contributed by Mahdi Fakhmanesh, December 2020.

Page 343: Figure 3.79

The figure is incorrect and the gain should be around 6 dB considering a CTR of 2 with this type of optocoupler:

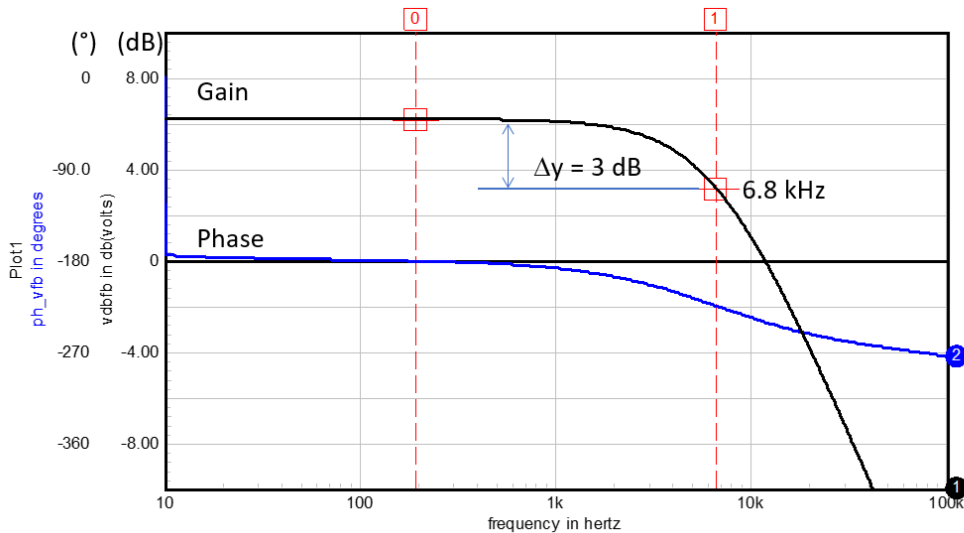

Contributed by Mark Derhake, September 2020.

Page 346: In this example, the value of k is 6.42 (4-kHz crossover, wanted phase margin of 70° and gain deficit of 11.3 dB) and the calculated values for the pole and zero are goofed:

$$f_z = \frac{f_c}{k} = \frac{4k}{6.42} = 623 \text{ Hz} \quad (3.126)$$

$$f_z = k \cdot f_c = 4k \times 6.42 = 25.7 \text{ kHz} \quad (3.127)$$

$$R_{LED} = \frac{CTR \cdot R_{pullup}}{G} = \frac{2 \times 20k}{3.67} = 10.9 \text{ k}\Omega \quad (3.131)$$

Contributed by Mahdi Fakhmanesh, December 2020.

Page 347: In the text of bullet 1.: ...the LED current increases to $(19-1-2.5)/10.9k = 1.42 \text{ mA}$.

Contributed by Mahdi Fakhmanesh, December 2020.

Page 379: Figure 3.21

The text comment is obviously $G = 60 \text{ dB} - 6 \text{ dB} = 54 \text{ dB}$ and not 56.
Contributed by Dmitry Kurzni, March 2015.

Chapter 4

Figure 4.15: the timing capacitor is obviously not $1 \mu\text{F}$ but 1 nF .
Contributed by Rongcui Dong, August 2014.

Page 403: The latch code for a PSpice latch is incorrectly that of an IsSpice one and the right one is given below:

PSpice latch

```
.SUBCKT LATCH 6 8 2 1
```

```

* S R Q Qb
E_BQB 10 0 VALUE = { IF ( (V(8)<2.5) & (V(2)>2.5), 100m, 5 ) }
E_BQ 20 0 VALUE = { IF ( (V(6)<2.5) & (V(1)>2.5), 100m, 5 ) }
RD1 10 1 100
CD1 1 0 10P IC=5
RD2 20 2 100
CD2 2 0 10P IC=100m
.ENDS FFLOP

```

Contributed by Mahdi Fakhmanesh, December 2020

Figure 4.33: the figure shows the correspondence between coupled inductors affected by a coupling coefficient k and an equivalent transformer representation. The leakage term is correct but the turns ratio needs to account for k as well as the equivalent primary inductance. A quick simulation confirms the expressions:

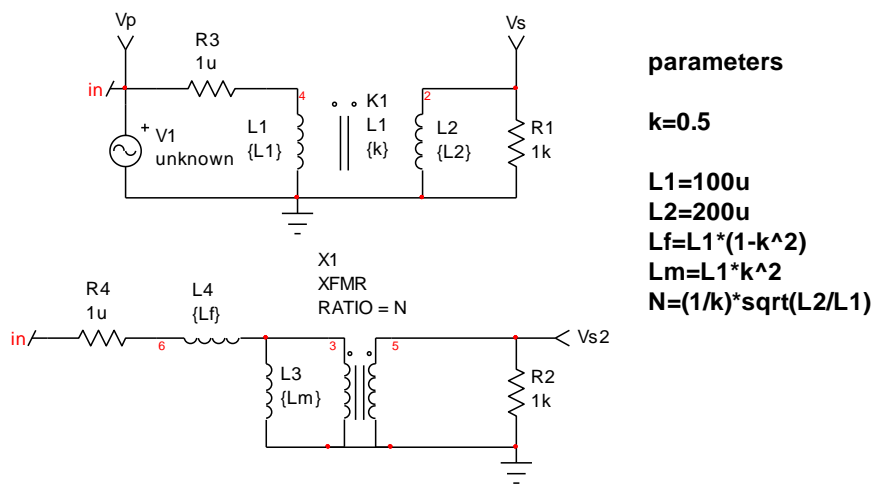

Simulation results appear below and show exact correspondence between output signals for a common excitation level:

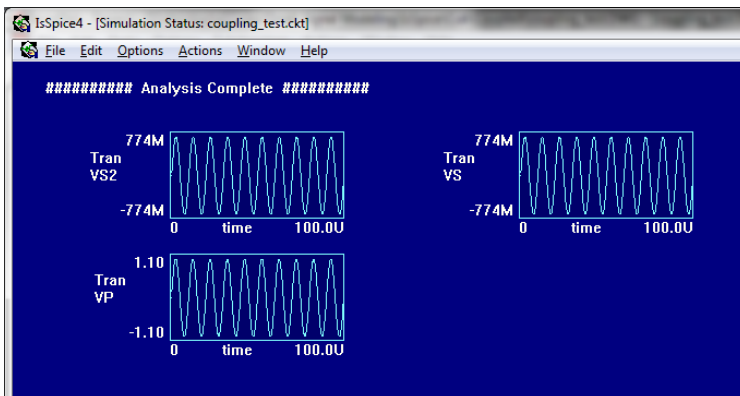

Page 414: The timing capacitor is 1 nF not 1 μ F.

Contributed by Mahdi Fakhmanesh, December 2020

Chapter 5

Page 465: The slope calculation in Figure 5.17 did consider a 10-mΩ resistance while in the text it is 8 mΩ. The final value passed to the PWM switch model is 2.5 mV/μs or 2.5 kV/s. If you want to stick to the calculations in page 466, the correct value to pass is 2 kV/s.

Contributed by Mahdi Fakhmanesh, December 2020

Page 492: The (1-D) value is obviously $1 - 0.535 = 46.5\%$. You can correct (5.89) result to $0.818 / 0.465 = 1.76$ and update the other equation: $S_a = 410.3$ kV/s and $S'_a = 16.4$ kV/s

Contributed by Mahdi Fakhmanesh, December 2020

Chapter 7

Page 655: In figure 7.20, the $i_{\text{sec}}(t)$ numerator should be $i_{\text{LP}}(t) - i_{\text{leak}}(t)$.

Contributed by Ye Zhao, June 2017.

Page 805: ...now using (7.479)...should be (7.476).

Contributed by Yann Vaquette, November 2014.